

800x2400mm

15mm Thickness

ERIC[®]

REDEFINED BEAUTY



INDEX

SIZE & THICKNESS.

800 x 2400 x (15mm)



LAVA IVORY

LAVA FULL
BODY BLACK

LAVA FULL
BODY WHITE

LAVA
DARK GREY

LAVA
LIGHT GREY

LAVA
BLACK

ROCK
WHITE

ROCK
GREY

ROCK
BLACK

ROCK
BEIGE

LAVA
WHITE

EXUDES
EFFORTLESS SOPHISTICATION

EDGE PROFILES



Micro bevel



Double straight rounded edge



Straight squared edge



Double straight squared edge



Rounded straight edge



Half bullnose



Squared edge at 45°



Hollywood Bevel



Full bullnose



Demi bullnose

JOINT POSSIBILITIES



Birds beak



45° corner



Soft corner

To enhance the beauty of the tiles, a precision trim can be given to them. Its thickness makes it possible to shape the edges of tiles in different styles and create aesthetically rich counter tops as required. Tiles with nicely trimmed edges also make for cleaner and elegant joints.



ROCK WHITE

SIZE & THICKNESS.

800 x 2400 x (15mm)

TYPE.

FULL BODY

FINISH.

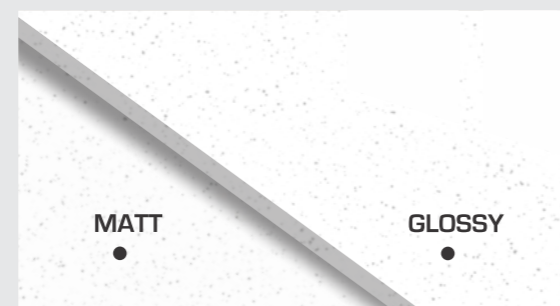

OFFICE
TABLE



STAIRCASE



TABLE
TOP



SHELVES



KITCHEN
COUNTER TOP



DINING
TABLE



DOOR / WINDOW
FRAME

ROCK GREY

SIZE & THICKNESS.

800 x 2400 x (15mm)

TYPE.

FULL BODY

FINISH.

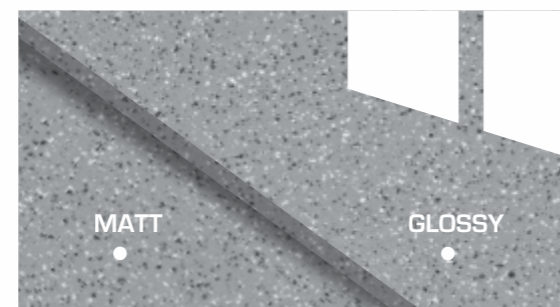

ROCK BLACK

SIZE & THICKNESS.

800 x 2400 x (15mm)

TYPE.

FULL BODY

FINISH.

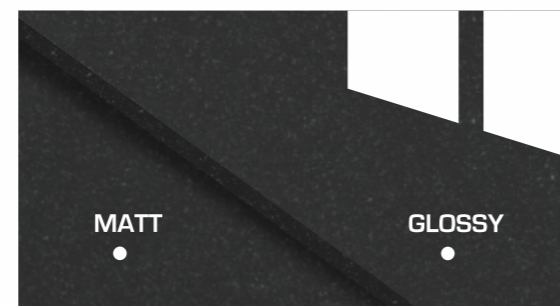

ROCK BEIGE

SIZE & THICKNESS.

800 x 2400 x (15mm)

TYPE.

FULL BODY

FINISH.

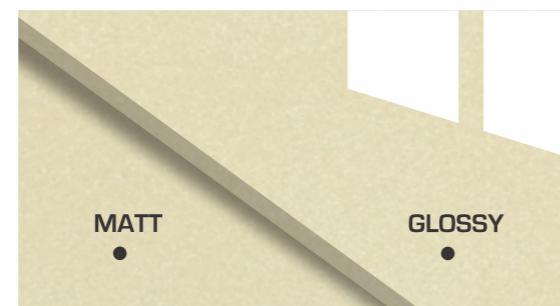

LAVA WHITE

SIZE & THICKNESS.

800 x 2400 x (15mm)

TYPE.

COLOUR BODY

FINISH.



OFFICE
TABLE



STAIRCASE



TABLE
TOP



SHELVES



KITCHEN
COUNTER TOP



DINING
TABLE



DOOR / WINDOW
FRAME

LAVA BLACK

SIZE & THICKNESS.

800 x 2400 x (15mm)

TYPE.

COLOUR BODY

FINISH.

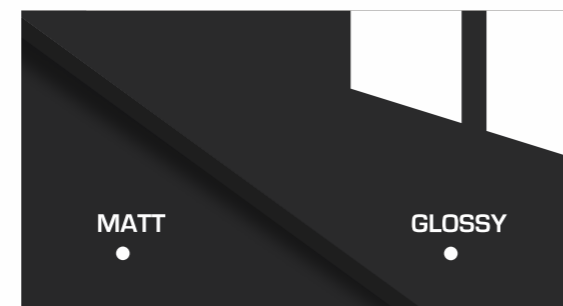

LAVA LIGHT GREY

SIZE & THICKNESS.

800 x 2400 x (15mm)

TYPE.

FULL BODY

FINISH.



LAVA DARK GREY

SIZE & THICKNESS.

800 x 2400 x (15mm)

TYPE.

FULL BODY

FINISH.



OFFICE
TABLE



STAIRCASE



TABLE
TOP



SHELVES



KITCHEN
COUNTER TOP



DINING
TABLE



DOOR / WINDOW
FRAME

LAVA IVORY

SIZE & THICKNESS.

800 x 2400 x (15mm)

TYPE.

FULL BODY

FINISH.



LAVA FULL BODY
WHITE

SIZE & THICKNESS.

800 x 2400 x (15mm)

TYPE.

FULL BODY

FINISH.



OFFICE
TABLE



STAIRCASE



TABLE
TOP



SHELVES



KITCHEN
COUNTER TOP



DINING
TABLE



DOOR / WINDOW
FRAME

LAVA FULL BODY BLACK

SIZE & THICKNESS.

800 x 2400 x (15mm)

TYPE.

FULL BODY

FINISH.





OFFICE TABLE



STAIRCASE



TABLE TOP



SHELVES



KITCHEN COUNTER TOP



DINING TABLE



DOOR / WINDOW FRAME

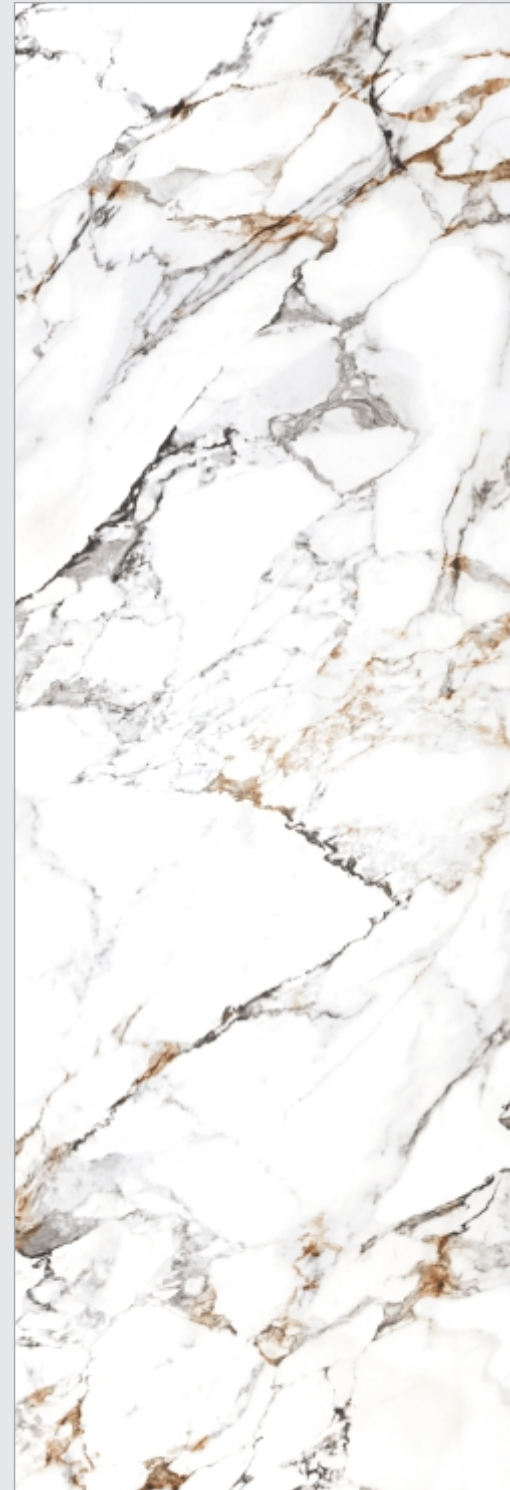

Arabescato Gold

Size 800x2400mm
Thickenss 15mm
Finish Glossy
Body White Colour Body



Brazilian

Size 800x2400mm
Thickenss 15mm
Finish Glossy
Body White Colour Body

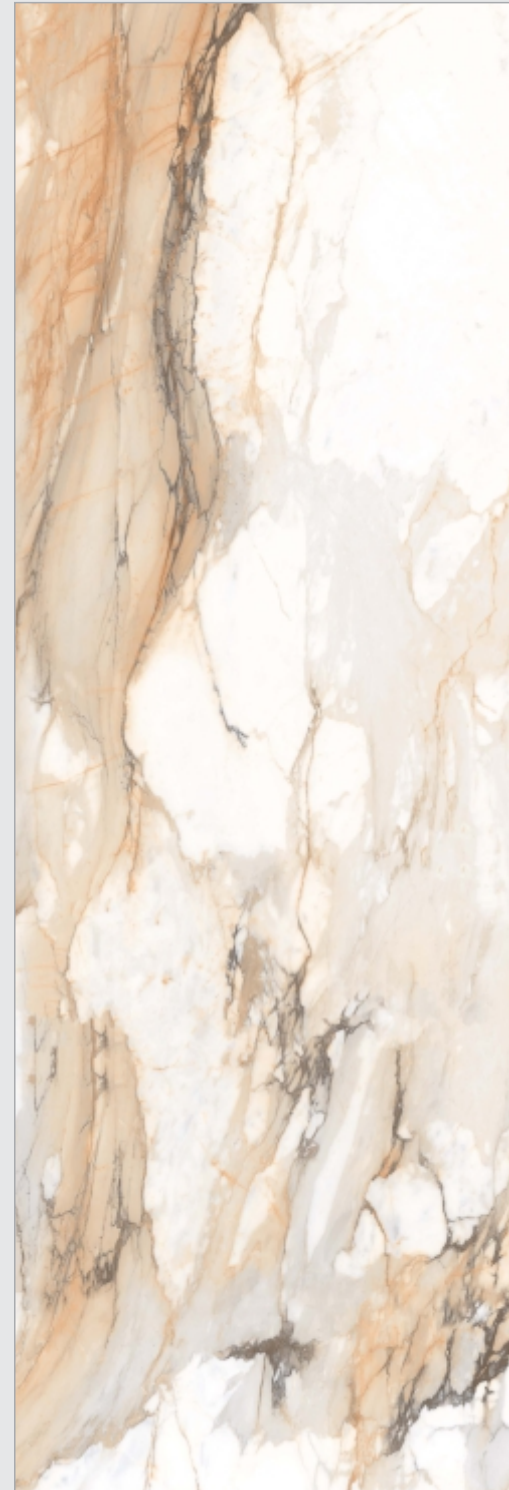

Calacatta Gold

Size 800x2400mm
Thickenss 15mm
Finish Glossy
Body White Colour Body



Pabbles White

Size 800x2400mm
Thickenss 15mm
Finish Glossy
Body White Colour Body



Pantagonia White

Size 800x2400mm
Thickenss 15mm
Finish Glossy
Body White Colour Body



OFFICE TABLE



STAIRCASE



TABLE TOP



SHELVES



KITCHEN COUNTER TOP



DINING TABLE



DOOR / WINDOW FRAME

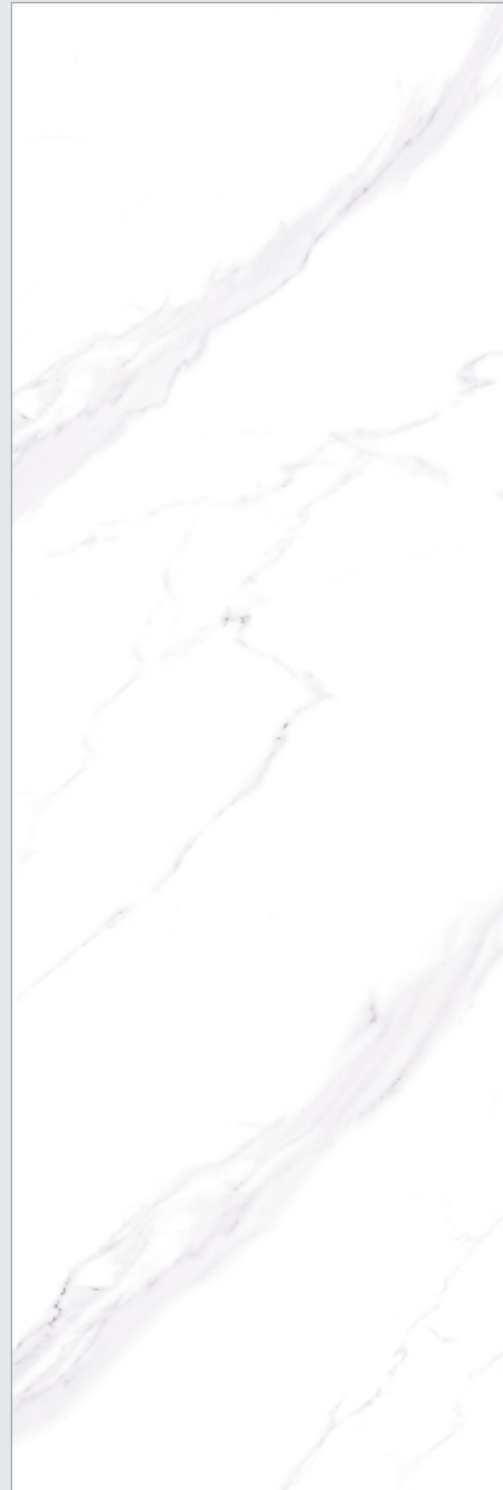

Calacatta Wow

Size 800x2400mm
Thickenss 15mm
Finish Glossy
Body White Colour Body

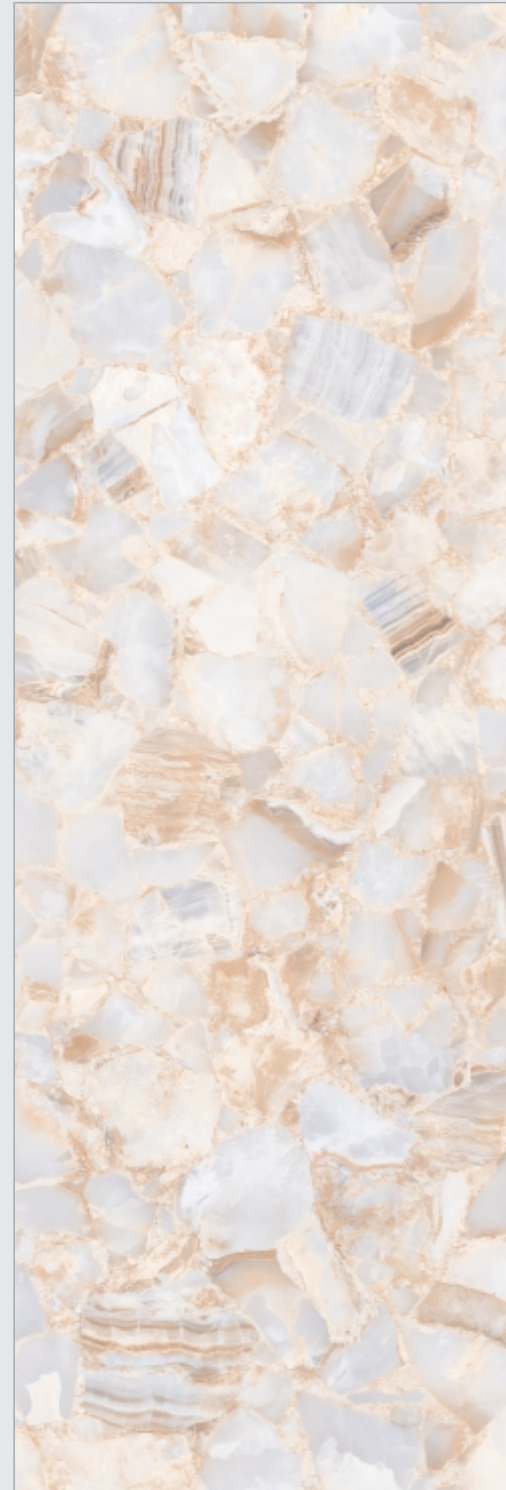

Prostone Ivory

Size 800x2400mm
Thickenss 15mm
Finish Glossy
Body White Colour Body

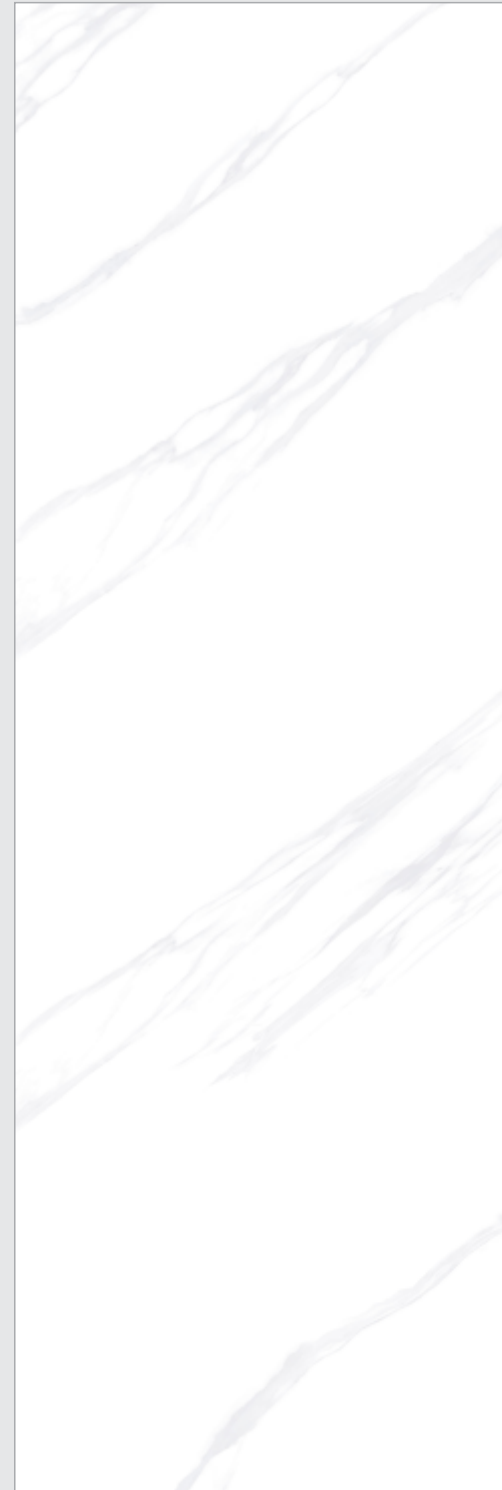

Helix White

Size 800x2400mm
Thickenss 15mm
Finish Glossy
Body White Colour Body

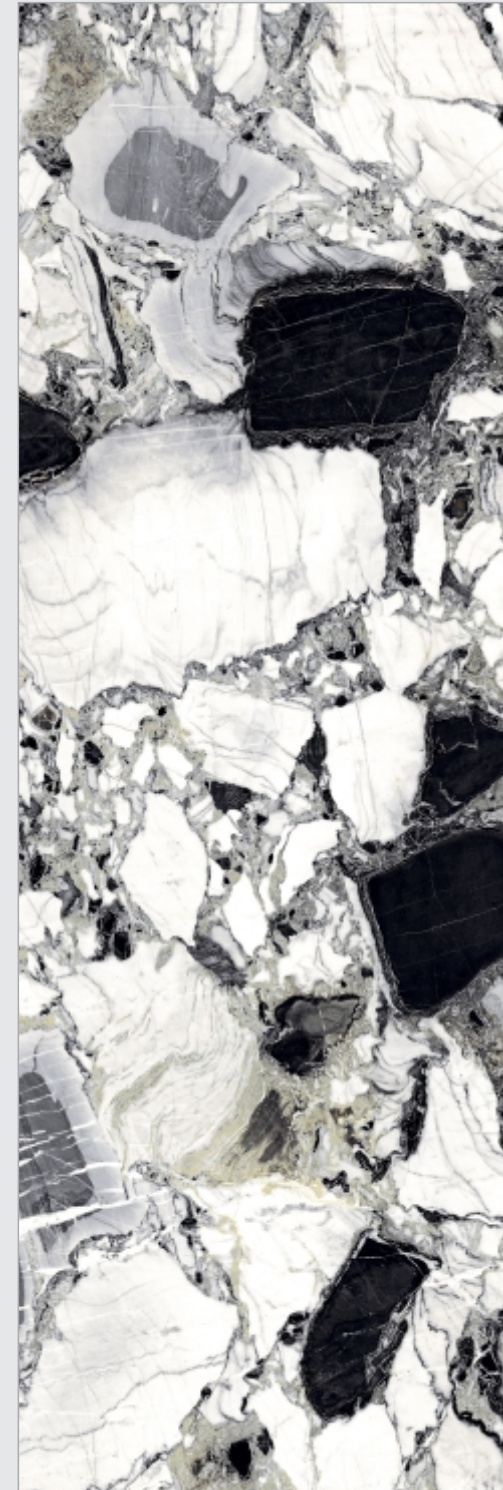

Matrix White

Size 800x2400mm
Thickenss 15mm
Finish Glossy
Body White Colour Body

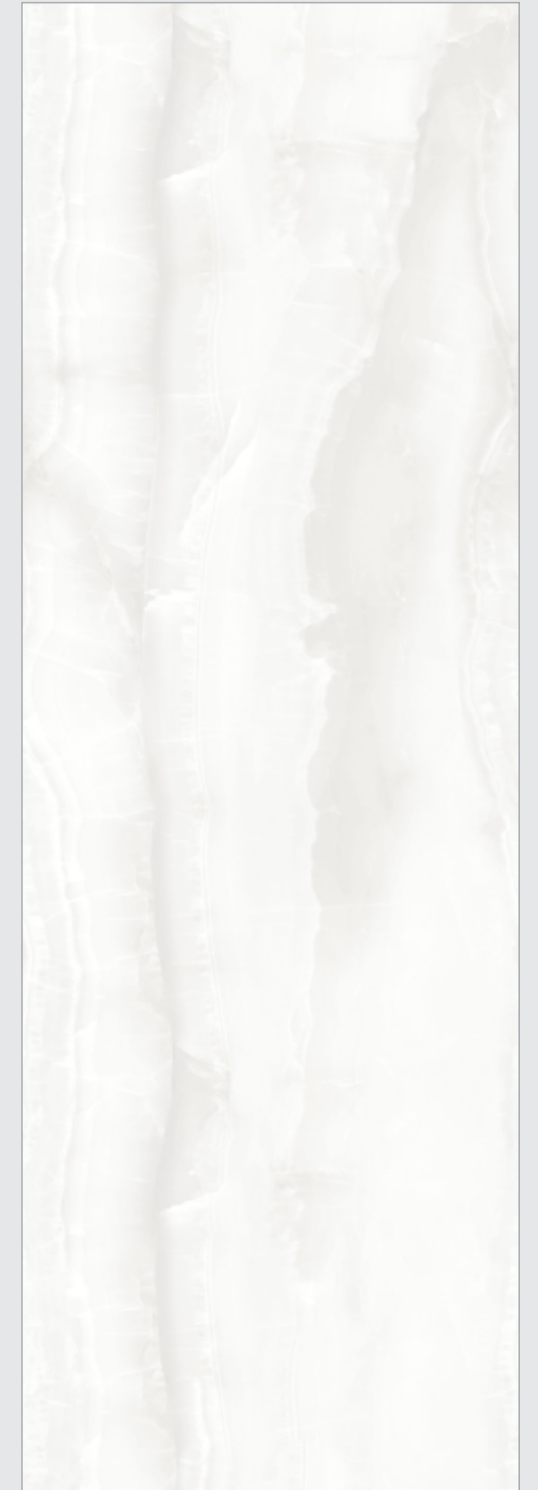

Onyx White

Size 800x2400mm
Thickenss 15mm
Finish Glossy
Body White Colour Body



OFFICE TABLE



STAIRCASE



TABLE TOP



SHELVES



KITCHEN COUNTER TOP



DINING TABLE



DOOR / WINDOW FRAME

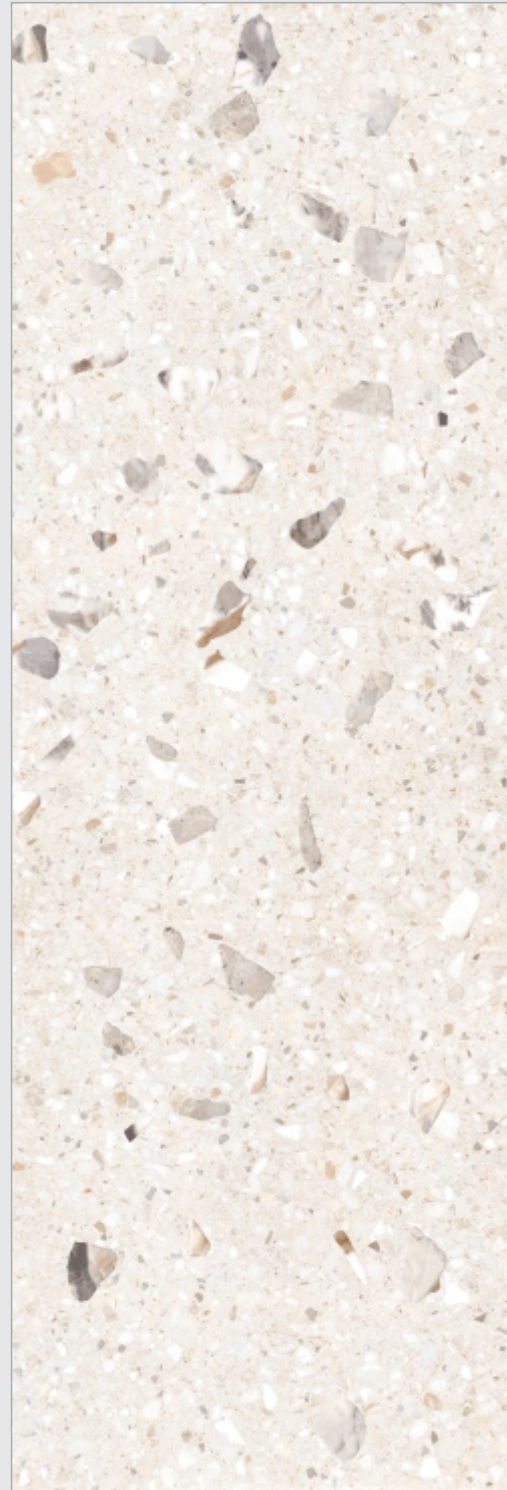

Terrazzo Bianco

Size 800x2400mm
Thickenss 15mm
Finish Glossy
Body White Colour Body

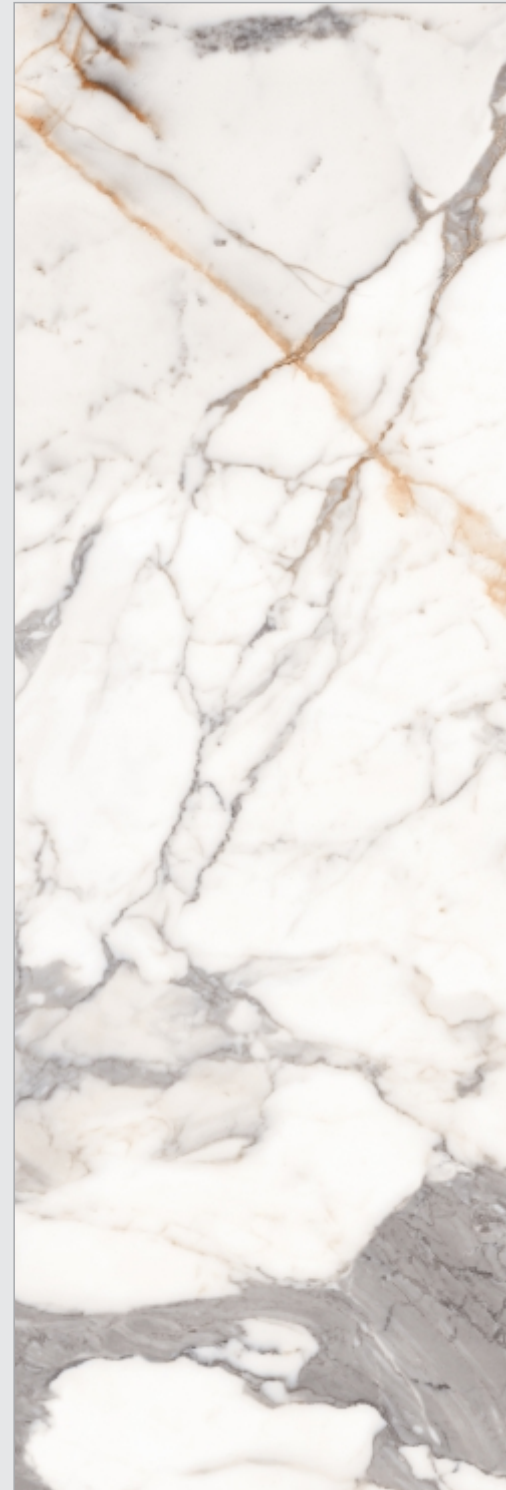

Timeless Calcatta Borghini

Size 800x2400mm
Thickenss 15mm
Finish Glossy
Body White Colour Body



Statuario Ice

Size 800x2400mm
Thickenss 15mm
Finish Glossy
Body White Colour Body





OFFICE TABLE



STAIRCASE



TABLE TOP



SHELVES



KITCHEN COUNTER TOP



DINING TABLE



DOOR / WINDOW FRAME



Breccia Beige

Size 800x2400mm
Thickenss 15mm
Finish Glossy
Body Ivory Colour Body



Breccia Max

Size 800x2400mm
Thickenss 15mm
Finish Glossy
Body Ivory Colour Body



Dayna Turkish

Size 800x2400mm
Thickenss 15mm
Finish Glossy
Body Ivory Colour Body



Smart Crema

Size 800x2400mm
Thickenss 15mm
Finish Glossy
Body Ivory Colour Body



Travertino

Size 800x2400mm
Thickenss 15mm
Finish Glossy
Body Ivory Colour Body



OFFICE TABLE



STAIRCASE



TABLE TOP



SHELVES



KITCHEN COUNTER TOP



DINING TABLE



DOOR / WINDOW FRAME



Pietra Grey

Size 800x2400mm
Thickenss 15mm
Finish Glossy
Body Grey Colour Body

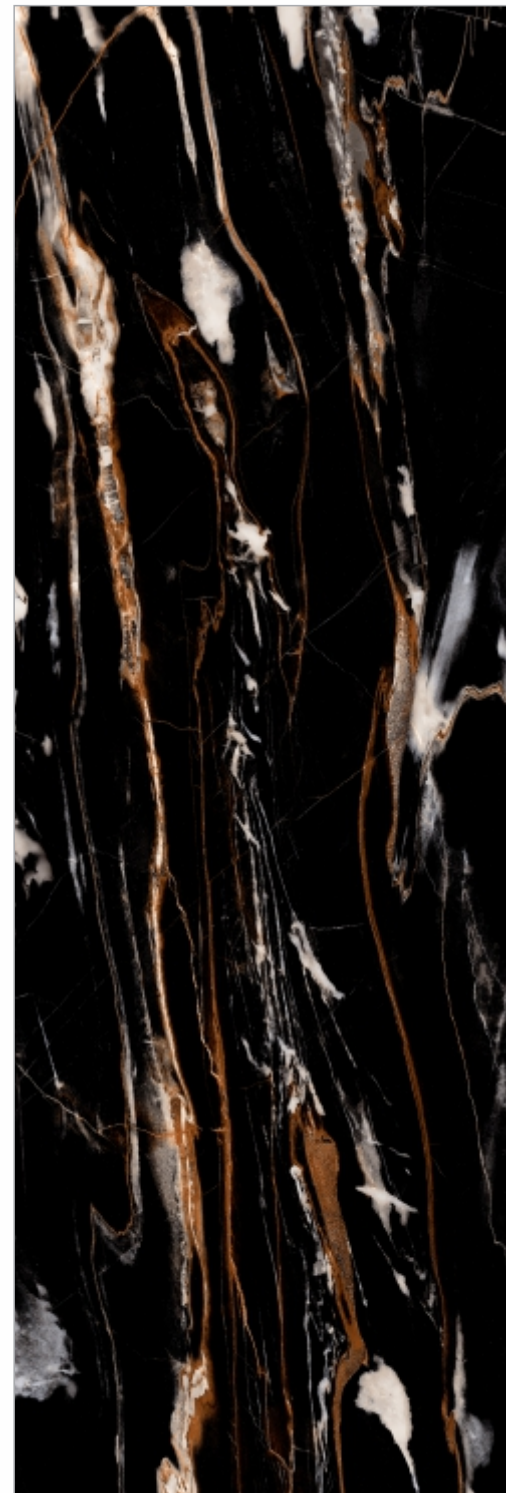

Ambrato Nero

Size 800x2400mm
Thickenss 15mm
Finish Glossy
Body Black Colour Body

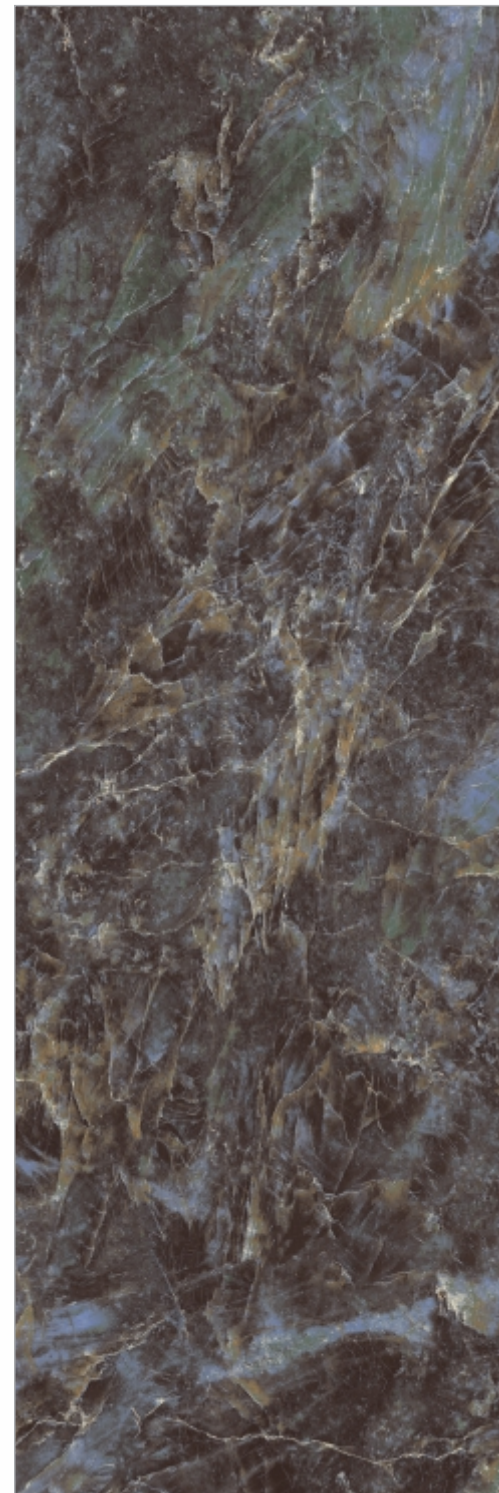

Arizona Blue

Size 800x2400mm
Thickenss 15mm
Finish Glossy
Body Black Colour Body

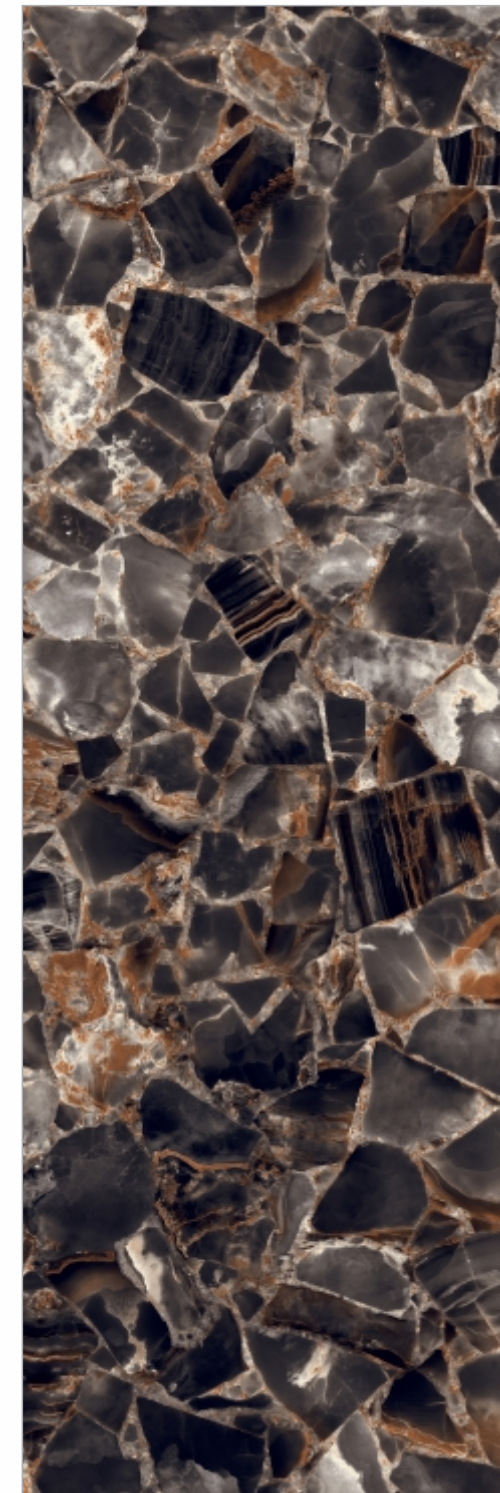

Emerald Quartz

Size 800x2400mm
Thickenss 15mm
Finish Glossy
Body Black Colour Body

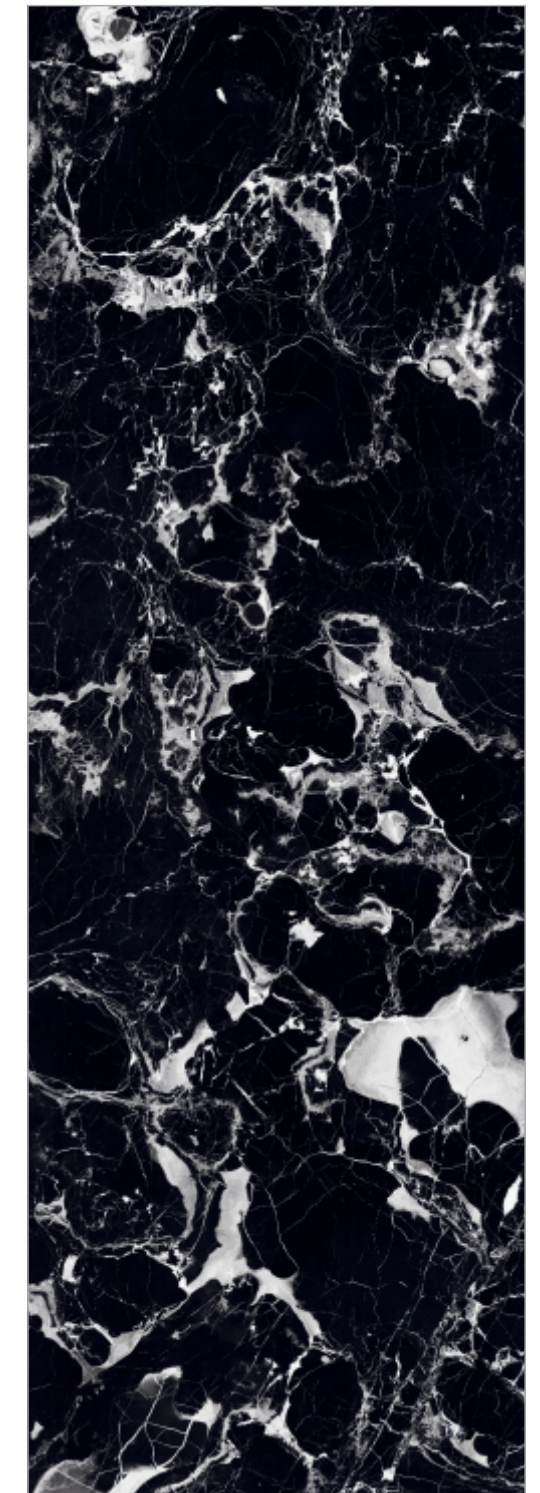

Portoro Black

Size 800x2400mm
Thickenss 15mm
Finish Glossy
Body Black Colour Body



OFFICE
TABLE



STAIRCASE



TABLE
TOP



SHELVES



KITCHEN
COUNTER TOP



DINING
TABLE



DOOR / WINDOW
FRAME

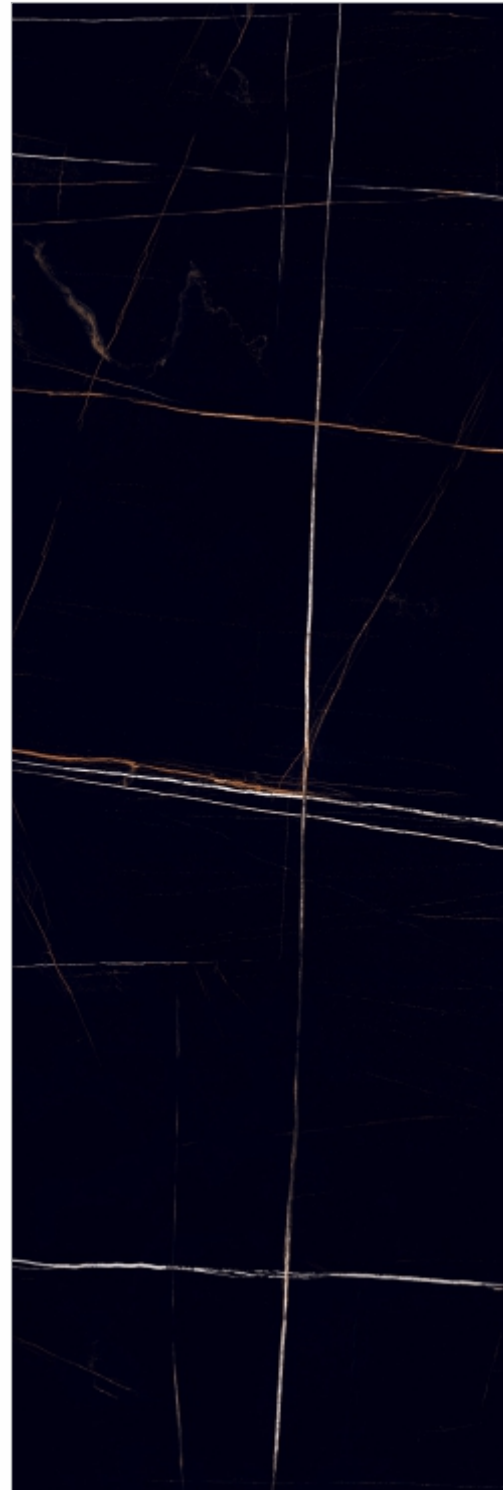

Saint Laurent

Size 800x2400mm
Thickenss 15mm
Finish Glossy
Body Black Colour Body

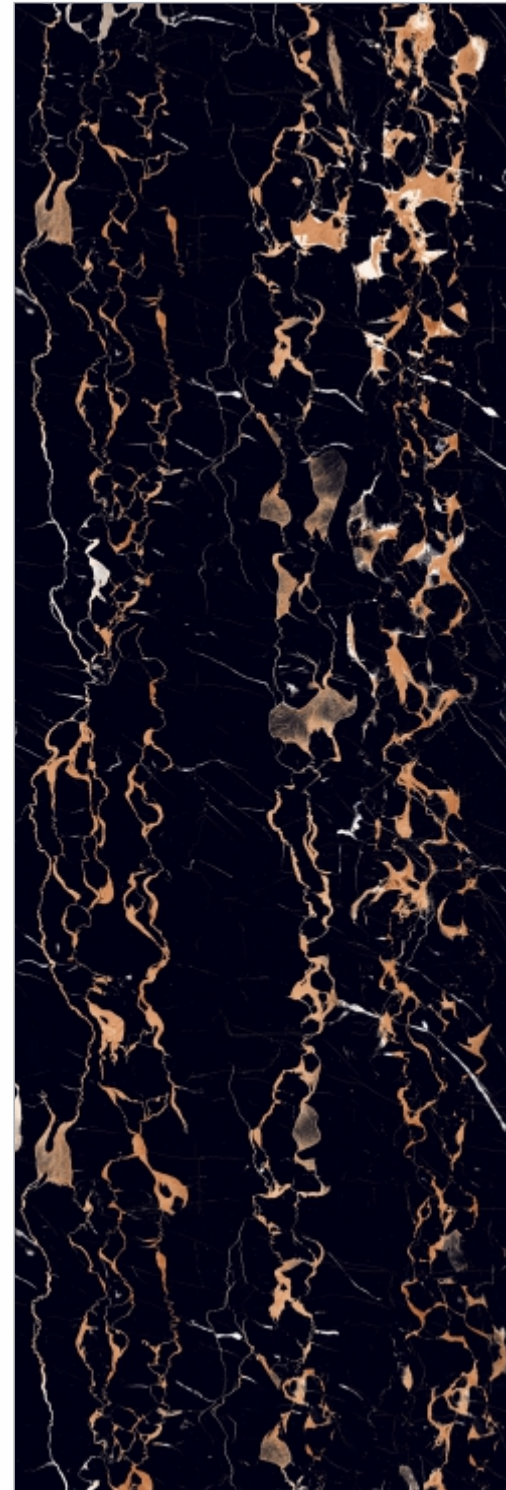

Portoro Gold

Size 800x2400mm
Thickenss 15mm
Finish Glossy
Body Black Colour Body



Retrowood Black

Size 800x2400mm
Thickenss 15mm
Finish Glossy
Body Black Colour Body

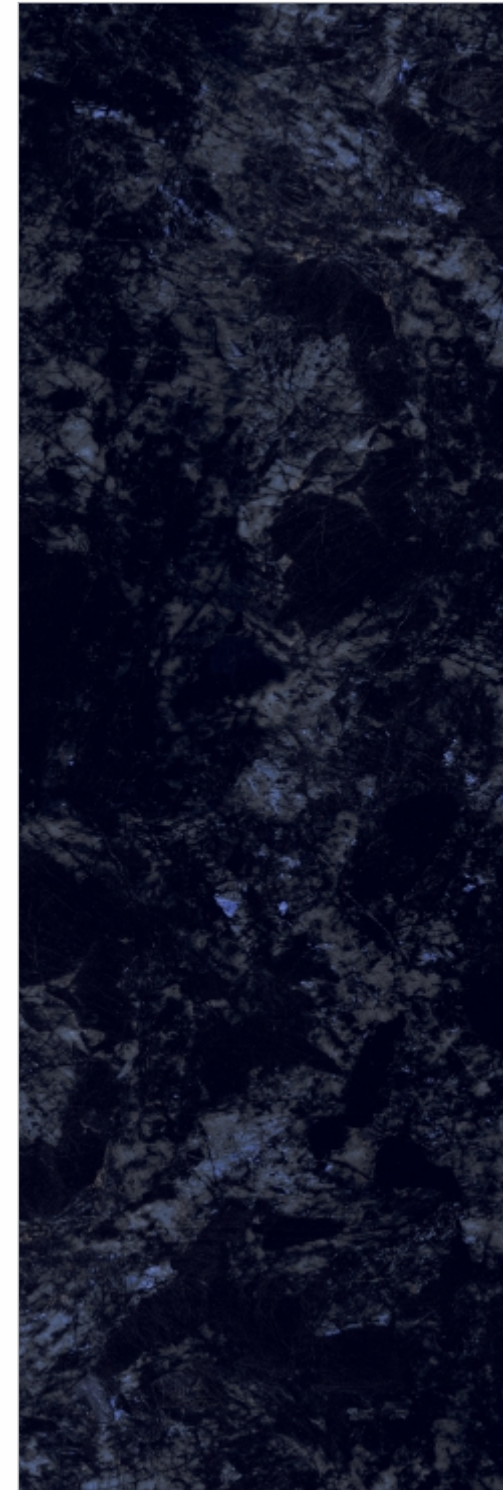

Volga Blue

Size 800x2400mm
Thickenss 15mm
Finish Glossy
Body Black Colour Body



Unique Negro

Size 800x2400mm
Thickenss 15mm
Finish Glossy
Body Black Colour Body



OFFICE TABLE



STAIRCASE



TABLE TOP



SHELVES



KITCHEN COUNTER TOP



DINING TABLE



DOOR / WINDOW FRAME

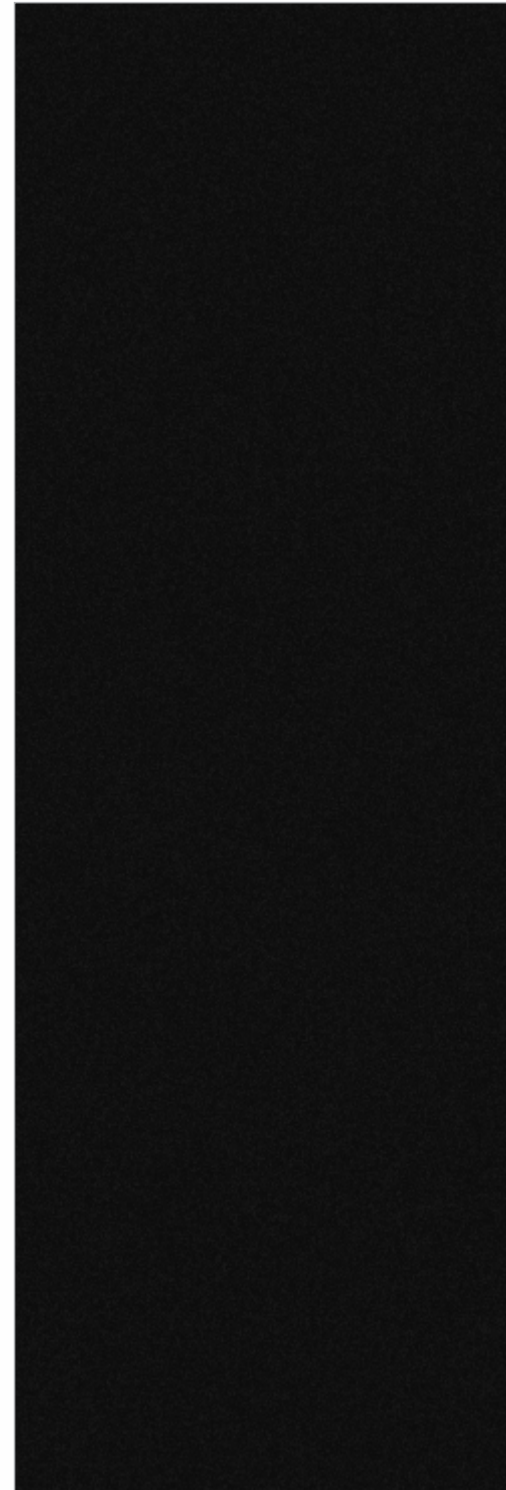

Sunshine Crestal Black

Size 800x2400mm
Thickenss 15mm
Finish Matt Carving
Body Black Colour Body

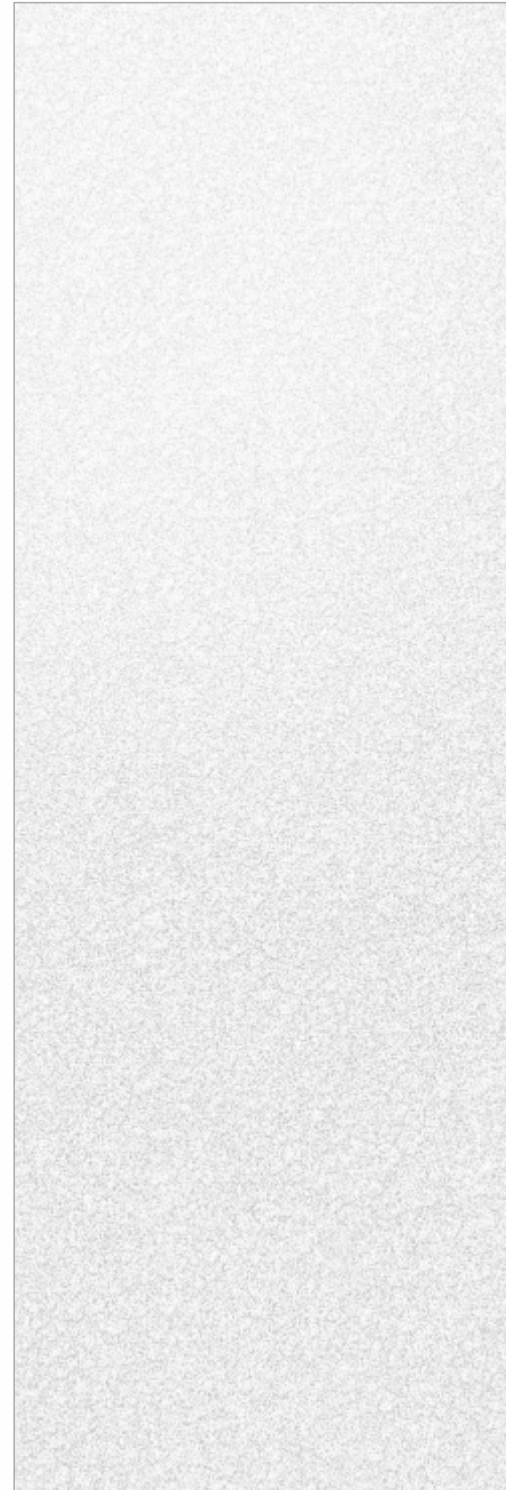

Sunshine Crestal

Size 800x2400mm
Thickenss 15mm
Finish Matt Carving
Body White Colour Body



Sunshine Fancy Black

Size 800x2400mm
Thickenss 15mm
Finish Matt Carving
Body Black Colour Body



Sunshine Fancy

Size 800x2400mm
Thickenss 15mm
Finish Matt Carving
Body White Colour Body

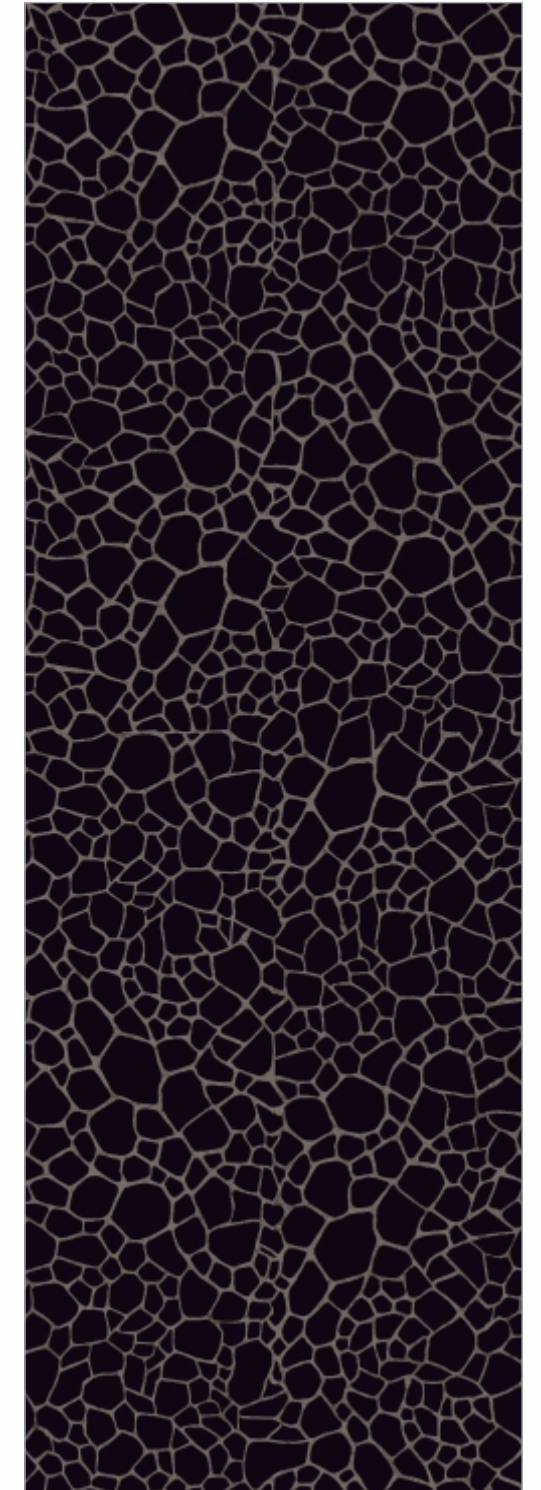

Sunshine ILLuminate Black

Size 800x2400mm
Thickenss 15mm
Finish Matt Carving
Body Black Colour Body

MANUALLY TRANSPORTING TILES

Only for 1/4" Slabs

MOVING A TILE

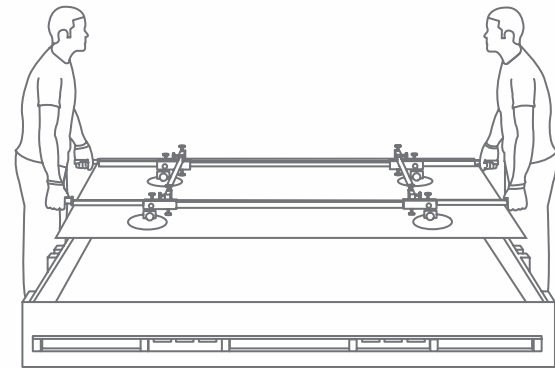
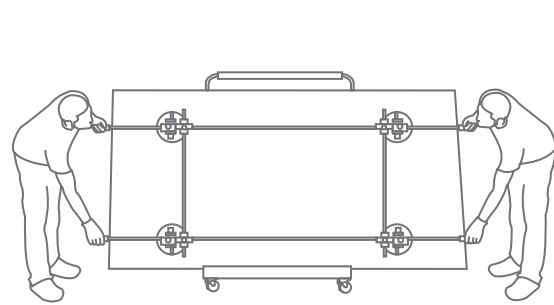

RAISING A IMMEDIATE TILE ONTO A BENCH

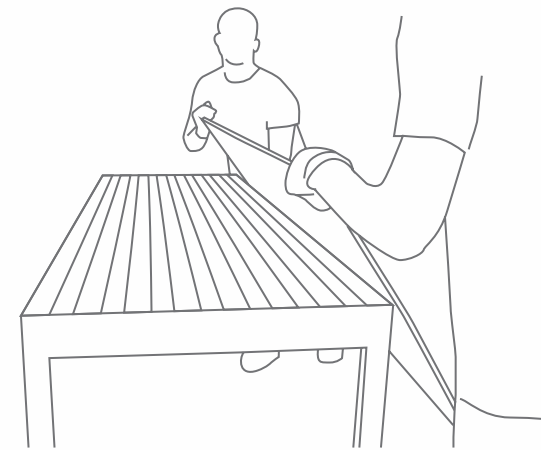
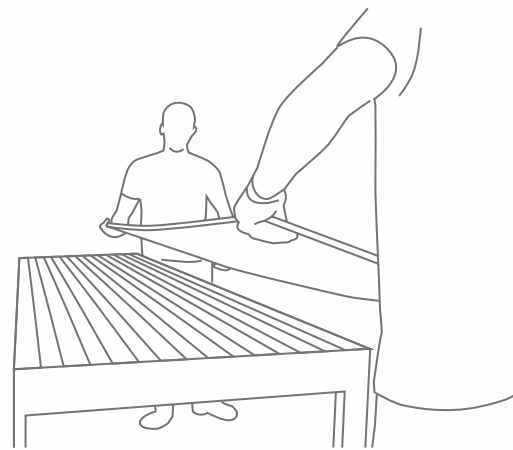

✗ INCORRECT

✓ CORRECT

HANDLING IMMEDIATE TILE FOR WALL

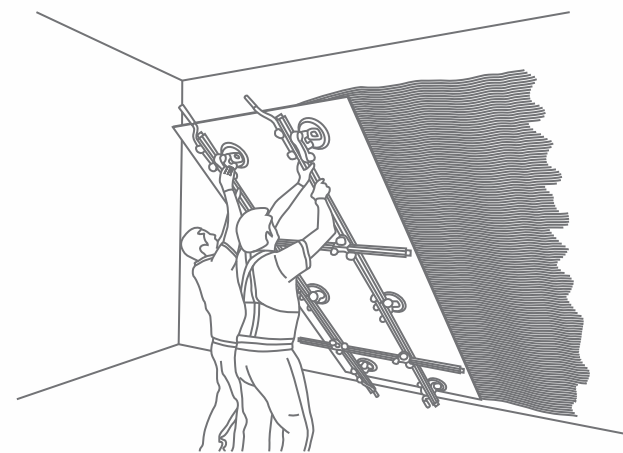
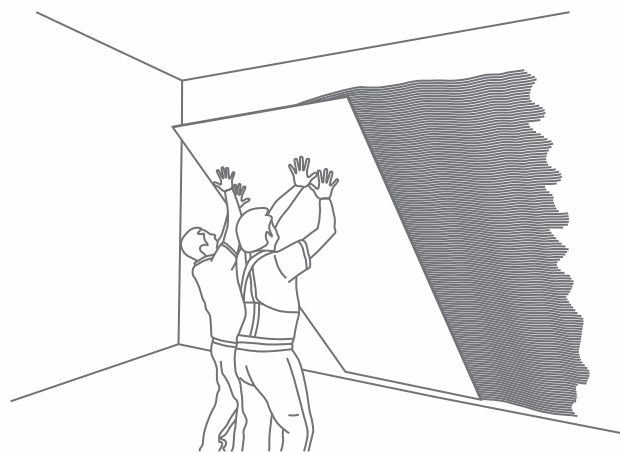

✗ INCORRECT

✓ CORRECT

WORKING WITH THE VARIOUS VERSIONS OF TILES

CUTTING WITH DIAMOND DISCS

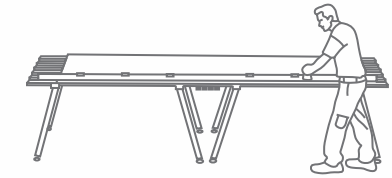
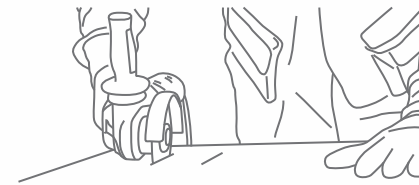

Our products can be cut using diamond discs fitted onto the hand-held electrical grinding machine. The speed of Disc rotation must be high (>10000 RPM) and should have a low feed rate (< 1 m/min). It may be required to cool the disc with water. Recommended discs are the thin types generally used for cutting porcelain stoneware. The surface should be kept on a FLAT base while cutting without any gap underneath

DRILLING

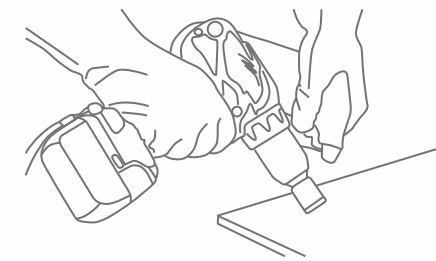
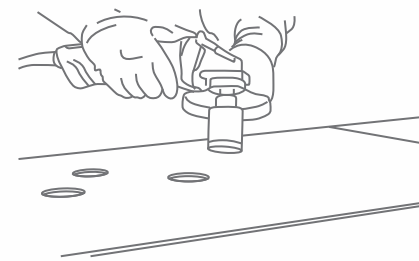

You can use cutting discs fitted to battery-operated screwdrivers or angle grinders, electrical drills as an alternative.

INTERNAL CUT / L-SHAPED CUT

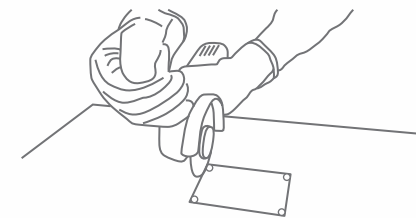

To get internal and L-shaped corners & to reduce the risk of breakage, round o the vertex of the internal corner using bits with a radius of at least 5mm. Then cut with diamond discs, be cautious to stop moving the cutting tool forward. To drill and cut using diamond discs, follow the instructions provided above.

When using these tools:
 -Cool the point being drilled with water
 -Don't put too much pressure and bear in mind the resistance of the type of laminated stoneware you are working on
 -If you are using tungsten bits, start drilling at a low speed
 -If you are using drills or screwdrivers, do not select hammering mode

EDGE-FINISHING

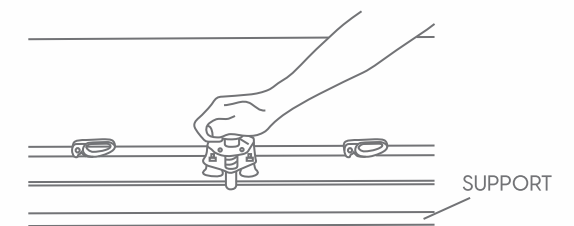
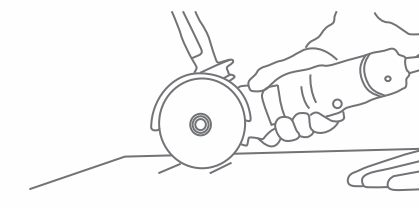
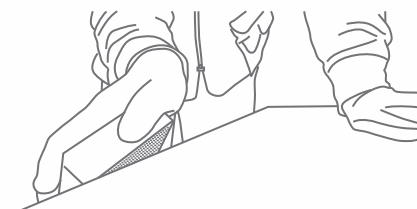

INSTRUCTIONS FOR MANUAL INSTALLATION

SINGLE LAYER METHOD



DOUBLE-LAYER METHOD

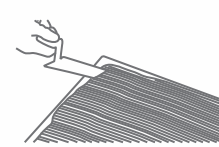

COMPRESSING THE TILE



IMPORTANT

All cutout corners must have a minimum diameter of 1/4". Never leave 90° angles. We recommend radiuses of more than 1/4" when the kitchen the design allows as it makes the countertop firmer.



✓ CORRECT



✗ INCORRECT



✗ INCORRECT



✗ INCORRECT

CLEANING & MAINTENANCE

Our products are non porous (due to their high quality raw materials, stringent production parameters and state of the art technology), hence any dust or deposited waste cannot penetrate the surface.

For most cases only a damp cloth is sufficient for cleaning.

Regular cleaning highlights the aesthetic features of the surface and gives it exceptional shine.

For highly aggressive cleaning caused by some common food and substances follow the table below.

TYPE OF STAIN	CHEMICAL PRODUCT	EXAMPLE
Grease	Alkaline - Solvent	Detergent
Oil	Solvent	Ammonia, Backing Soda
Ink	Oxidant - Solvent	Alcohol, Liquid Bleach, Nail Paint Remover
Rust	Acid	Hydrochloric Acid, Vinegar, Red Harpic
Lime	Acid	Descaling Reagent, Hydro Chloric Acid
Cement	Acid	Hydro Chloric Acid
Wine	Alkaline	Ammonia, Liquid Bleach
Coffee	Alkaline - Solvent	Ammonia, Liquid Bleach
Rubber	Solvent	Alcohol, Thinner
Plaster	Acid	Hydro Chloric Acid
Candle Wax	Solvent	Alcohol, Thinner
Iodine	Oxidant	Liquid Bleach
Blood	Oxidant	Liquid Bleach
Ice Cream	Alkaline	Liquid Bleach

Note: It is recommended that any kind of stain needs to get clean immediately / as soon as possible.

TECHNICAL SPECIFICATIONS

CHARACTERISTIC	STANDARD AS PER ISO-13006/2018 En14411 gr.bla	MOTTO VALUE	TEST METHOD
Regulatory Properties			
Deviation in Length & Width	±0.5%	±0.2%	ISO 10545-2
Deviation in Thickness	±5%	±5%	ISO 10545-2
Straightness of Sides	±0.5%	±0.2%	ISO 10545-2
Rectangularity	±0.5%	±0.2%	ISO 10545-2
Surface Flatness	±0.5%	±0.3%	ISO 10545-2
Colour Difference	ΔE<1.00	ΔE<0.30	ISO 10545-16
Glossiness	As per Mfg.	As Per Mfg.	GlossMeter
Structural Properties			
Water Absorption	≤0.5 %	≤0.3 %	ISO 10545-3
Apparent Density	As Per Mfg.	>2.20 g/cc	ISO 10545-3
Massive Mechanical Properties			
Modulus of Repture	Min.35N/mm ²	Min.40N/mm ²	ISO 10545-4
Breaking Strength	Min. 1300 N	Min. 2000 N	ISO 10545-4
Impact Resistance	As per Mfg.	Min. 0.55	ISO 10545-4
Surface Mechanical Properties			
Surface Abrasion Resistance	As per Mfg.	Min. class 3	ISO 10545-7
Moh's Hardness	As per Mfg.	Min. class 4	BS EN 15771
Thermo Hygrometric Properties			
Frost Resistance	As Per Mfg.	Frost Proof	ISO 10545-12
Thermal Shock Resistance	Min. 10 Cycle	Min. 10 Cycle	ISO 10545-9
Moisture Expansion	Max. 0.6mm/m	Max. 0.02mm/m	ISO 10545-10
Thermal Expansion	Max. 9.0 x 10 ⁻⁶	Max. 6.0x10 ⁻⁶	ISO 10545-8
Chemical Properties			
Chemical Resistance	As Per Mfg.	No Damage	ISO 10545-13
Stain Resistance	Resistant	Resistant	ISO 10545-14
Safety Properties			
Slip Resistance	As per Mfg.	N. A.	DIN 51130
Fire Resistance	As per Mfg.	Fire Proof	N. A.

PACKING DETAILS

Dimension (mm)	No. of PC's/Box	Square Feet	Weight (Approx)
800x2400mm	1 Pcs.	20.66 Sq. Feet	68 Kg.